

TRANSMISSION TEAR-DOWN BENCH INSTALLATION INSTRUCTIONS

IMPORTANT: To reduce the risk of serious injury, read and understand this entire guide before beginning any installation.



Contents

BEFORE YOU BEGIN:3

SAFETY WARNINGS:.....3

TRANSMISSION TEAR-DOWN BENCH4

 Regular Cleaning.....6

WARRANTY7

BEFORE YOU BEGIN:

1. Check your inventory to be sure you received your entire order. If there are any missing or damaged parts, contact your **Dealer** or **Borroughs Corporation Customer Service Manager**.
2. Read and understand the entire installation instructions prior to beginning the install.

SAFETY WARNINGS:



This symbol is used to address practices not related to personal injury.



A potentially hazardous condition exists that may result in death or serious injury, property damage, or destruction if instructions are not strictly observed.



This symbol is used to address practices not related to physical injury.

Once installation is completed, a copy of the installation instruction booklet **MUST** remain with the customer.

Hardware:

07792-00
Screw 5/16-18 X 1/2

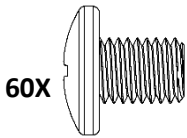

17213-00
Nut 5/16-18



Tools Required:

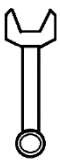

TRANSMISSION TEAR-DOWN BENCH

STEPS

- 1** Use two (2) 14812-00 leg weldments (#10) and bolt two (2) 11103-00 stringer channels (#12) together using eight (8) 07792-00 screws and eight (8) 17213-00 Keps nuts.

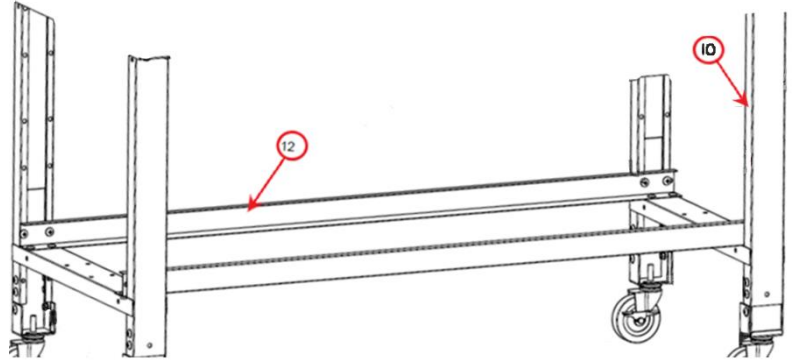

- 2** Turn unit upside down, then take four (4) 14846-00 caster plates (#5) and place threaded bolt on casters (#4 & #6) through centered hole of bracket. Use four (4) 17213-00 Keps nuts on threaded bolt.

NOTE: For best results place both casters with brakes on same end of bench.

- 3** Use four (4) 14891-00 casters with plates and mount them to four (4) 14809-00-foot adjustable brackets (#7) lining up bottom holes of bracket. Use eight (8) 07792-00 screws and eight (8) 17213-00 Keps nuts to mount.



- 4** Place four (4) 14809-00-foot adjustable brackets (#7) and slide into bottom of leg weldments (#10) to the preferred height and mount using sixteen (16) 07792-00 screws and sixteen (16) 17213-00 Keps nuts. Tighten hardware. **Now turn bench right-side up.**

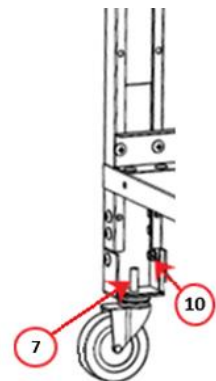

- 5** Bolt together two (2) 14813-00 leg attachment channels (#9) and two (2) 11100-00 C-channel bench top 48 in. (#3) attach to leg weldment using eight (8) 07792-00 screws and eight (8) 17213-00 Keps nuts.
- 6** Now place frame just built in step 5 and place on top of bench. Bolt to frame using four (4) 00792-00 screws and four (4) 17213-00 Keps nuts bolting **ONLY on the inside** of leg attachment channel (#9) on both ends.

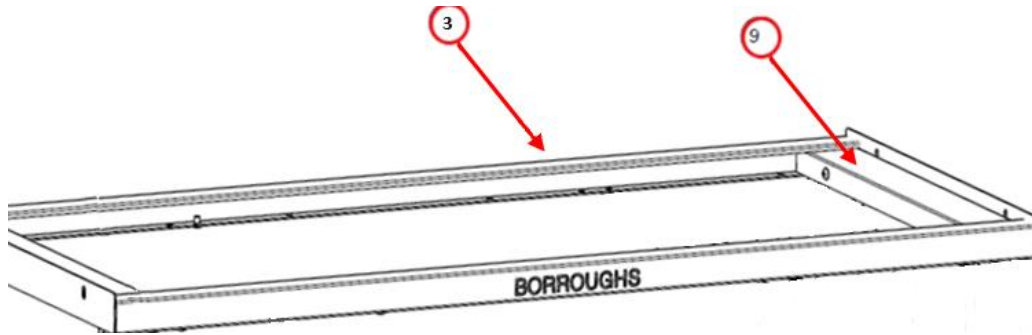

- 7** Bolt two (2) Guide Pan Supports 28in to bench top frame using four (4) 07792-00 screws and four (4) 17213-00 Keps nuts and tighten. Then you can place one (1) 11107-00 Pan Fluid Containment (#11) to supports.

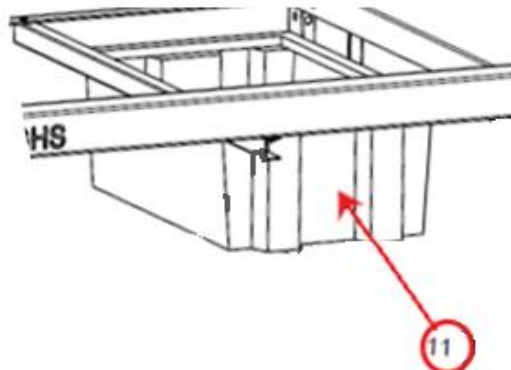

- 8** Place 11105-00 fluid drain top 48" x 28" either stainless or painted and top of structure and bolt to legs using bolt to framing using four (4) 00792-00 screws and four (4) 17213-00 Keps nuts bolting to **OUTSIDE** of 14813-00 leg attachment channel (#9) on both outside ends. Tighten all hardware.

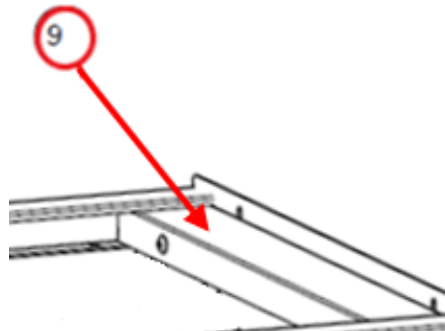

Once installation is completed, a copy of the installation instruction booklet **MUST** remain with the customer.

Regular Cleaning

Use a soft clean cloth and mild soap or detergent to wipe the surfaces. Dry completely with a soft clean cloth using straight line motion.



Do not use abrasives (ex. scratchers, steel wool).



WARRANTY

Borroughs Corporation extends to the original purchaser from the date of purchase a limited lifetime warranty for Borroughs' Automotive Workstations, Modular Drawer Cabinets, and eCommerce Purchased Products, against manufacturing defects in material and workmanship. For all other products Borroughs extends to the original purchaser from the date of purchase a 5-year limited warranty against manufacturing defects in material and workmanship.

If a Borroughs product fails to perform because of a manufacturing defect, Borroughs will examine it. If found defective, it will be repaired or replaced at our option. This warranty applies only to Borroughs products acquired directly from Borroughs Corporation or from Authorized Borroughs Dealers.

This warranty does not apply to any product which has been subject to misuse, negligence, or accident; has been damaged in shipment, storage, or installation; has been misapplied or has been modified or repaired by unauthorized persons or been repaired with non-standard Borroughs replacement parts. This warranty specifically excludes claims for indirect, incidental, or consequential damages arising in any way from a product defect. This warranty is exclusive, and exists in lieu of all other warranties, either expressed or implied.

This warranty gives you specific legal rights; you may also have other rights which may vary from state to state.

Contact your Borroughs Selling Dealer, to obtain warranty service. You must make a written claim. Provide a copy of your purchase record and a written description of the warranty problem with your claim.

If you are unable to contact your Dealer, contact:
Borroughs Corporation, Customer Service Manager,
3002 N. Burdick St., Kalamazoo, MI 49004-3483.
Phone: 1-800-748-0227